

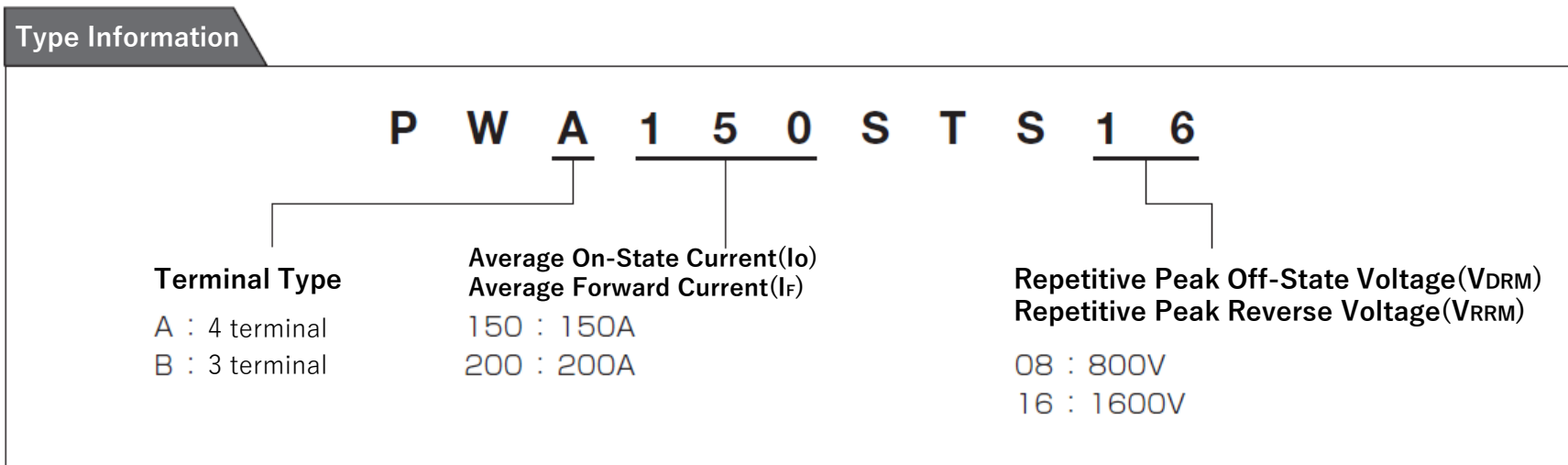

Power Module features and Type information?



- Possible for customizable by packaging technology which meets customer needs.
- Lineup of 150A type and 200A type in the same package.
- Original structure design improves heat dissipation.
- UL approved standard.

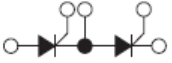
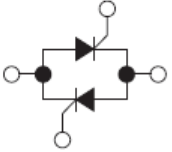

JEL SYSTEM LINE-UP –Thyristor Module-

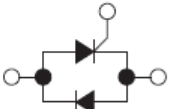
	Circuit	Model	V_{DRM}	I_o	I_{TSM}	T_{jw}
Thyristor Module		PWA150STS08	800	150	3200	-40~+125°C
		PWA150STS16	1600	150	3200	-40~+125°C
		PWA200STS08	800	200	4000	-40~+125°C
		PWA200STS16	1600	200	4000	-40~+125°C
		PWB150STS08	800	150	3200	-40~+125°C
		PWB150STS16	1600	150	3200	-40~+125°C
		PWB200STS08	800	200	4000	-40~+125°C
		PWB200STS16	1600	200	4000	-40~+125°C
		PWA150STA08	800	150	3200	-40~+125°C
		PWA150STA16	1600	150	3200	-40~+125°C
		PWA200STA08	800	200	4000	-40~+125°C
		PWA200STA16	1600	200	4000	-40~+125°C
		PWA150SDS08	800	150	3200	-40~+125°C
		PWA150SDS16	1600	150	3200	-40~+125°C
		PWA200SDS08	800	200	4000	-40~+125°C
		PWA200SDS16	1600	200	4000	-40~+125°C
		PWB150SDS08	800	150	3200	-40~+125°C
		PWB150SDS16	1600	150	3200	-40~+125°C
		PWB200SDS08	800	200	4000	-40~+125°C
		PWB200SDS16	1600	200	4000	-40~+125°C
	PWA150SDA08	800	150	3200	-40~+125°C	
	PWA150SDA16	1600	150	3200	-40~+125°C	
	PWA200SDA08	800	200	4000	-40~+125°C	
	PWA200SDA16	1600	200	4000	-40~+125°C	

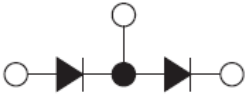

JEL SYSTEM LINE-UP –Diode Module–

	Circuit	Model	V_{RRM}	I_F	I_{FSM}	T_{jw}
Diode Module		PWA150DTS08	800	150	3200	-40~+150°C
		PWA150DTS16	1600	150	3200	-40~+150°C
		PWA200DTS08	800	200	4000	-40~+150°C
		PWA200DTS16	1600	200	4000	-40~+150°C
		PWB150DTS08	800	150	3200	-40~+150°C
		PWB150DTS16	1600	150	3200	-40~+150°C
		PWB200DTS08	800	200	4000	-40~+150°C
		PWB200DTS16	1600	200	4000	-40~+150°C



Power Module Package Type and Dimensions

PWA package

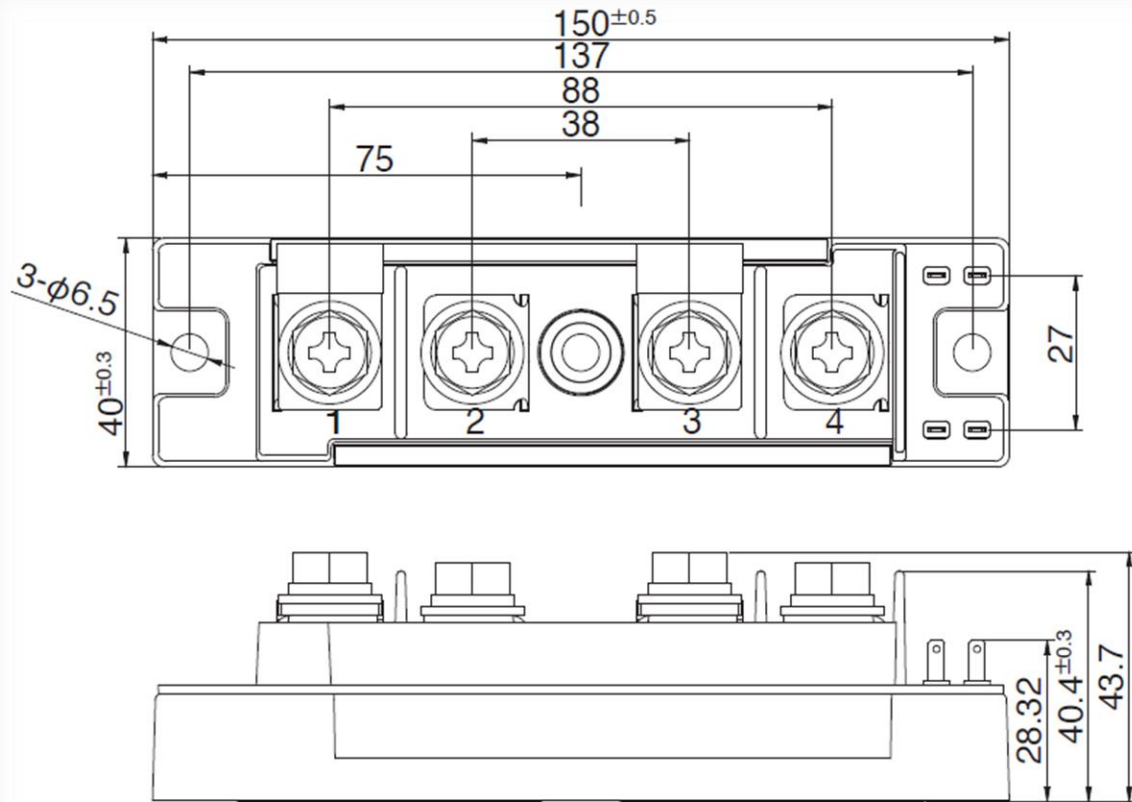

PWB package

