

DC Solid State Relay

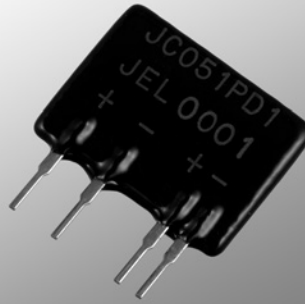

JCPD SERIES



Solid State Relay

JCPD series

Features

- Small size, Resin casted molding type
- Available for PCB high-density packaging
- Max. load current at 1.2A
- Dielectric strength between input and output at 2,500V/1 min.
- 3 ~ 24V input voltage
- Same design with JCP series

Type Information

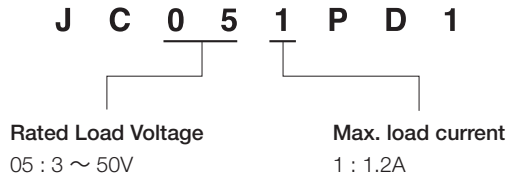

Characteristics

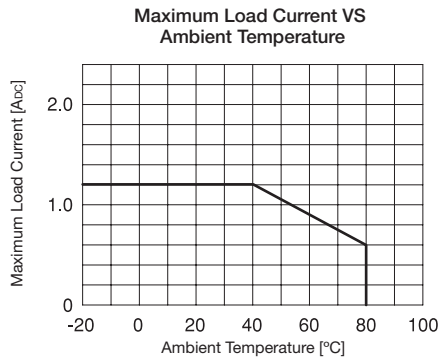

※ Description in the catalogue is subject to change without notice. Please read the specifications thoroughly before using.
 ※ Please contact JEL SYSTEM for further information.

Dimensions (mm)

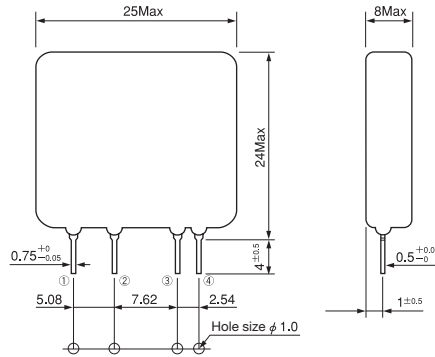

Dimensions For PCB Design

Equivalent Circuit

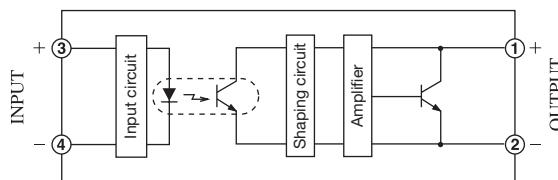

※ Description in the catalogue is subject to change without notice. Please read the specifications thoroughly before using.
 ※ Please contact JEL SYSTEM for further information.

■ Ratings

(Ta = 25 °C)

	Item	Symbols	JC051PD1	Units
Output	Maximum Load Voltage	V _{OMAX}	50	V _{DC}
	Load Voltage Range	V _O	Pure DC	3 ~ 50
			Bridge Rectification	35
	Maximum Load Current	I _{OMAX}	1.2	A _{DC} /A _{rms}
Surge Current Ratings	I _{SURGE}	3 (1 sec)	A	
Input	Maximum Input Voltage	V _{IMAX}	24	V _{DC}
	Input Impedance	R _{IN}	1.5 ± 20%	KΩ
General	Dielectric Strength	V _{ISO}	2,500/1 min. (Between input and output)	V _{ACrms}
	Isolation Resistance	R _{ISO}	10 ⁸ and above DC500V (Between input and output)	Ω
	Operating Temperature Range	T _{OPR}	- 20 ~ + 80	°C
	Storage Temperature Range	T _{STG}	- 30 ~ + 100	°C

■ Electrical Characteristics

(Ta = 25 °C)

	Item	Symbols	JC051PD1	Units
Output	Off State Leakage Current	I _{LEK}	10 and below (V _O = 50V _{DC})	μA _{DC}
	On State Voltage Drop	V _{SAT}	1.0 and below	V _{DC}
	Minimum Load Current	I _{OMIN}	0.1	mA
Input	Input Voltage Range	V _I	3.5 ~ 24	V _{DC}
	Operate Voltage	V _P	3.5 and below	V _{DC}
	Release Voltage	V _D	1.0 and above	V _{DC}
General	Operate Time	T _{ON}	2ms and below (Resistance load)	/
	Release Time	T _{OFF}	2ms and below (Resistance load)	/
	Capacitance	C _{IO}	15 and below	PF

※ Description in the catalogue is subject to change without notice. Please read the specifications thoroughly before using.

※ Please contact JEL SYSTEM for further information.

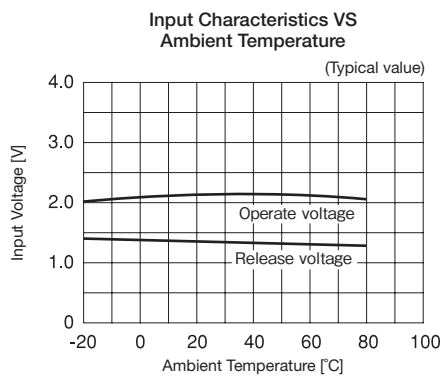
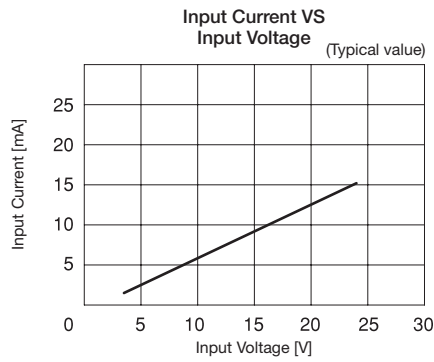
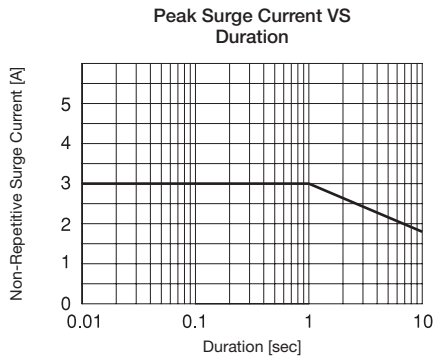

※ Description in the catalogue is subject to change without notice. Please read the specifications thoroughly before using.
 ※ Please contact JEL SYSTEM for further information.